

ENGLISH



Operating instructions

TANDBERG tape recorder 3400X

Contents

	Page
Automatic stop	4
Combined playback/amplifier function	8
Connections	5
Copying of tapes	5
Headphones	5
Loudspeakers	6
Microphone	5
Record player	5
Stereo amplifier/receiver	5
Controls and connectors – location of	3
Counter	4
Data	16
Echo	11
Editing	8
Flying start – playback to recording	9
Function table	14
Introduction	2
Language learning	11
Maintenance	15
Microphone amplifier – the recorder used as ..	8
Mixing	10
Monitoring of program during recording	7
Playback	7
Plugs	13
Power supply	4
Preparation for use	4
Recording	6
Sound-on-sound	9
Tape	4
Tape tracks	12
Tape splicing	12
Tone controls	7
Vertical mounting	4

Tandberg Series 3400 X

Series 3400X is a new range of tape recorders suited to the world's most discriminating markets in respect of quality and sound reproduction. The recorders are equipped with the revolutionary Tandberg Crossfield which extends the frequency range upwards and makes the lower tape speeds more useful. The input dynamic range has been extended up to 66 dB, and the input signal/noise ratio has been improved.

3400X recorders have separate heads for recording and playback providing source test (A) and tape test (B) monitoring as well as sound-on-sound and echo recording. The highly sensitive microphone inputs are intended for dynamic microphones with 200 to 700 ohms impedance. Separate inputs are provided for recording from record player, radio, amplifier, or microphone. A fast-rise, slow-decay (peak reading) record level meter on each channel indicates the program level applied to the record head. Stereo headphones may be connected for monitoring a recording or listening to playback.

The recorders feature a flying start from record to playback or vice versa. Series 3400X can also be used in the mono playback mode and as a microphone amplifier at the same time, with a choice of mixing methods. This makes the recorder well suited as a central unit in a music and speech distributing system.

The main amplifiers will deliver 2 x 5 watts to the internal speakers or 2 x 15 watts to external speakers.

Power pilot light and photoelectric end-stop sensor.

Rec button. Depress to record when one or both REC SELECT buttons are depressed.

Power switch.

Instantaneous start/stop lever.

Input level controls, channels L and R.

Microphone sockets, channels L and R.

Record level indicators, channels L (left) and R (right).

Buttons for preselection of recording channel, L or R or both.

Speed selector.

Front and rear head covers.

Counter indicating program position on tape.

Reset button for counter.

Tape transport lever.

Treble/Bass controls, channels L and R.

Output level controls, channels L and R.

Playback buttons, channels L and R.

Sound-on-sound and echo switch.

Stereo headphones socket.

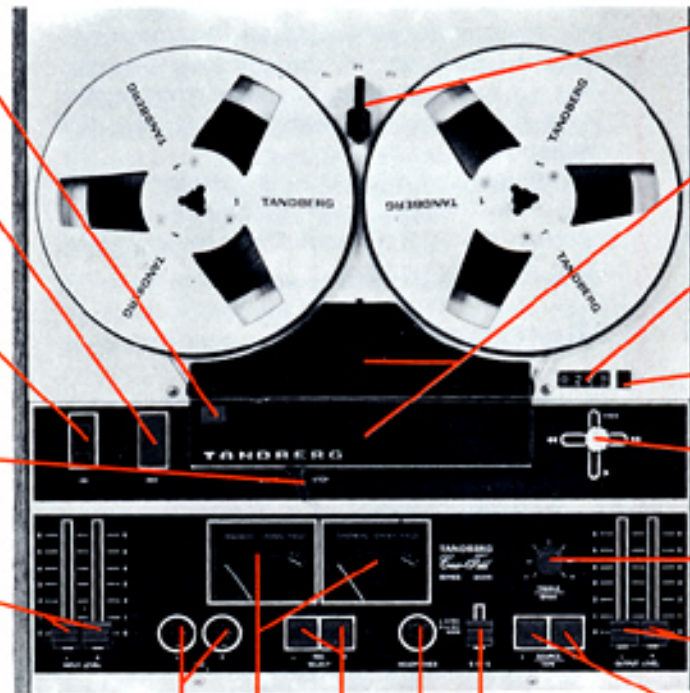

Power supply

Standard model: 230 V/50 Hz (English model: 240 V/50 Hz) easily rewired for 115 V. To change from 60 to 50 Hz (or 50 to 60 Hz), change the motor pulley and rewire the transformer. This operation should be performed only by a competent service technician.

Note: The photoelectric end-stop sensor will prevent the motor from starting until a tape has been properly inserted in the tape path. Wrong threading of the tape may prevent starting. If the tape has a transparent leader, the recorder will not start if the leader is in front of the photoelectric end-stop sensor. To avoid this turn the take-up reel by hand to move the transparent part of the tape away from the end-stop sensor or cut away the transparent leader tape.

Vertical mounting

The recorder can be used in a horizontal or vertical position, or any intermediate angle. The front is equipped with rubber feet for vertical mounting.

To prevent the tape reels from falling off or being displaced during vertical operation, lift the turntable spindles slightly and rotate 1/4 turn to lock the reels into place.

Tape

Tandberg tape recorders in the 3400X series are adjusted for recording on Tandberg High Output Low Noise (HL) tape or its equivalent. For a given distortion this tape gives a 3 to 4 dB higher output level than ordinary low noise tape.

If ordinary low noise tape is used for recording, the record level meter should not exceed the -2.5 dB mark if excessive distortion is to be avoided.

Automatic stop

A photoelectric end-stop sensor located at the left-hand tape-guide-post, operates a switch which stops the motor when the tape runs out or if the tape snaps.

If the tape reel has a transparent section of tape, the motor will also stop when this section is reached. This makes it possible to stop the recorder at the end of the tape without the tape running out.

The light for the photoelectric end-stop is also used as a "power-on" indicator. Owing to the automatic end-stop operation the motor will not start until a tape has been correctly inserted into the tape path.

Counter

The counter may be used in various ways to indicate positions of programs on tape. Set the counter to zero before recording.

Preparation for use

Connect the mains cable to a socket and switch the recorder on. Set the tape transport lever to the FREE position. Put a full tape reel on the left-hand turntable and an empty reel on the right-hand turntable as shown in the figure. Lift the turntable spindles slightly and rotate 1/4 turn to lock the reels into place.

Thread the tape through the tape path and place the end in the hub slot of the empty reel; take up the slack by turning the empty reel anticlockwise.

Reset the counter. Set the tape speed selector for the desired tape speed. The best sound quality is obtained at 7 1/2 ips, while 1 7/8 ips gives the longest playing time.



Connections

Microphone

For mono or stereo recording of live programs, connect one or two microphones respectively to inputs MIC L and R on the top panel.

The sensitivity from the MIC input automatically adjusts itself to suit any dynamic microphone with an impedance of 200 to 700 ohms. For mono recording the microphone amplifiers for channels L and R are connected in parallel. Thus recording can take place on either channel, irrespective of which input the microphone is connected to. If an orchestra or some other sound source is to be recorded in stereo, place the microphone connected to MIC R to the right of the sound source and the microphone connected to MIC L to the left of the sound source.

Note: Undesirable mixing may occur if another program remains connected to the RADIO socket while the MIC socket is in use.

Radio/amplifier

For mono or stereo recording and playback using a radio or an amplifier, connect a 5-pin DIN-cable from the RADIO socket underneath the tape recorder to the TAPE IN/OUT socket on the radio or amplifier.

Set the PHONO switch to "OFF" when recording from the radio or amplifier.

Headphones

Connect stereo headphones with a minimum impedance of 100 ohms to the socket HEADPHONES to obtain a fixed output level. Low impedance headphones (less than 100 ohms) can also be connected to the sockets LOUDSPEAKERS and the level adjusted by means of the OUTPUT LEVEL controls.

WARNING

To prevent damage to low impedance headphones, do not set the OUTPUT LEVEL controls too high.

Record Player

Connect a record player with a magnetic pick-up to the PHONO socket underneath the recorder via a 5-pin DIN lead. **Set the PHONO switch to "ON" when recording from the record player.**

Copying tapes

To copy stereo or mono tapes use a 5-pin DIN-lead with a pin reversal adapter connected from the RADIO socket on the 3400X to the corresponding socket(s) on the second tape recorder. **Set the PHONO switch to "OFF".**

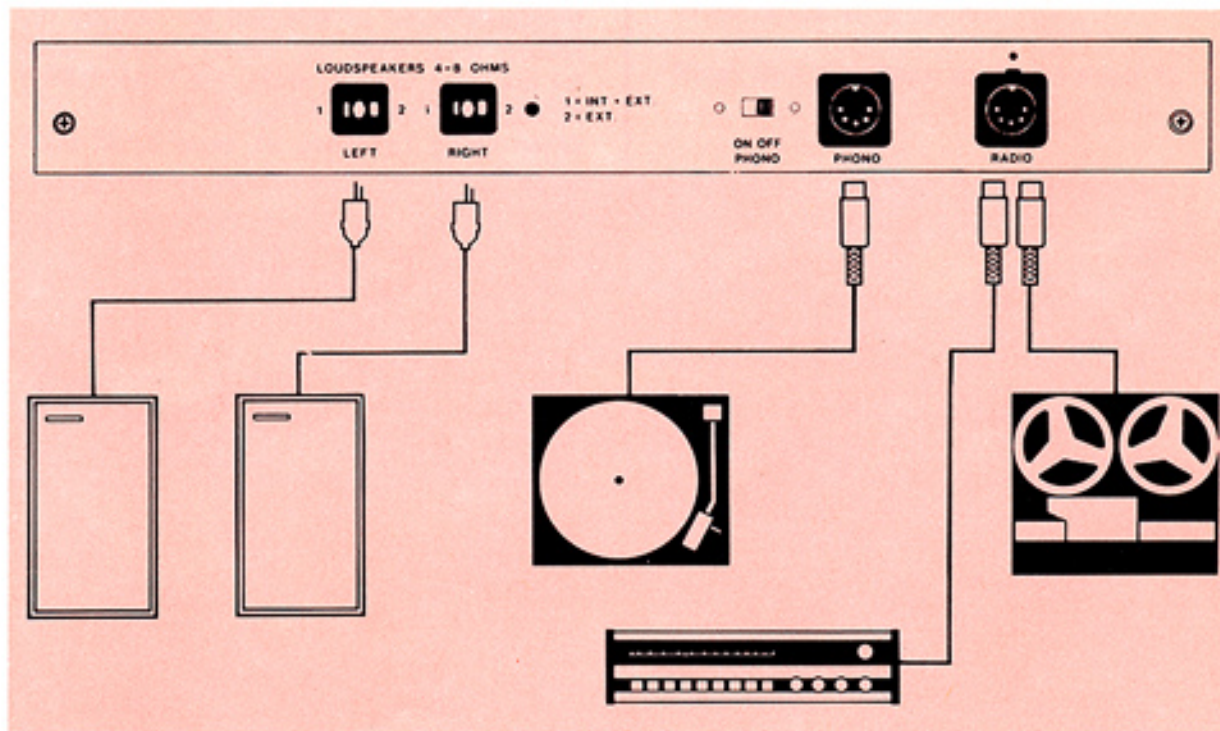

Connections, continued

Loudspeakers

Connect external speakers with 4 to 8 ohms impedance to DIN sockets LOUDSPEAKERS 4-8 OHMS LEFT and RIGHT. To use internal and external speakers together connect as shown in fig. A. To use only external speakers connect as shown in fig. B.

External speakers with 4 ohms impedance will give optimum output power (2x 15 watts).

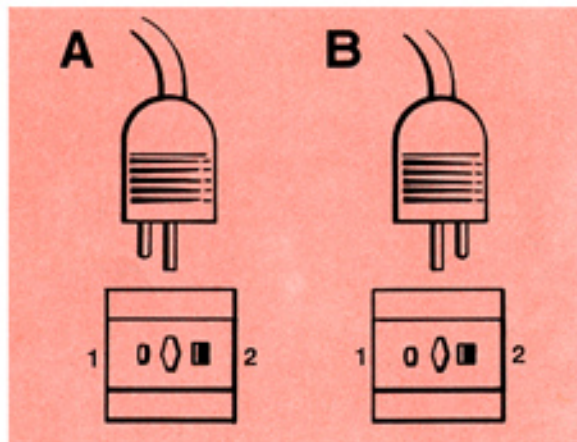

Recording

Mono

Connect external equipment as explained in previous section. Set START/STOP lever to STOP, and S ON S switch to NORM. Depress either the REC SELECT L or REC SELECT R button to record both stereo channels (or a mono program) on one track.

WARNING

Do not depress both REC SELECT buttons because mono recording will then be impossible and there will be a risk of destroying a wanted program on another track.

Depress REC button while moving tape transport lever to position ► Adjust the record level with the INPUT LEVEL knob for the input used (L or R). The other INPUT LEVEL knob should be set to zero.

When using Tandberg HL tape or an equivalent quality for recording, the meter should indicate 0 dB.

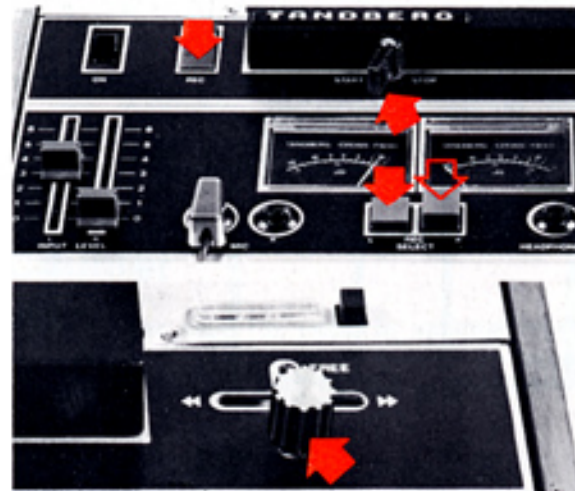

If ordinary low noise tape is used the meter should indicate approximately -2.5 dB. A higher record level will increase the distortion. Only during very short passages can the recommended record levels be exceeded without causing audible distortion. A record level that is too low will make the tape noise more noticeable.

Reset the counter. Start the recording by operating the START/STOP lever.

To check the quality of the recording, compare the recorded program with the original program (see paragraph on monitoring).

For short stops set the START/STOP lever to position STOP. For longer stops, move the tape transport lever to the centre position. The REC button will then be released.

Stereo

Connect the stereo program source to the tape recorder as explained in the section on Connections. The procedure for stereo recording is the same as for mono, except for the following:

Depress both REC SELECT L and R buttons. Both indicators will then be illuminated, and the program level for each channel can be set with the corresponding INPUT LEVEL knob.

Note 1: It may be necessary to set the INPUT LEVEL controls in slightly different positions to obtain correct indications on both record level meters. This is quite normal because the meters are more accurate than the scale on the controls.

Note 2: See also **Tape tracks** on page 12.

Monitoring a program during recording

1. The source of a program (radio, mic, tape, or disc) can be heard in headphones or loudspeakers before it is recorded. This source monitoring (or A-test as it is sometimes called) is obtained when the SOURCE/TAPE button for the particular channel is released. Source monitoring is normally carried out before recording starts to check that the quality is acceptable, and after recording has started to check that the quality continues to be acceptable. Source monitoring also makes it easier to record consecutive programs without stopping the tape.
2. During recording the quality of the recording itself can also be checked a fraction of a second after it has been recorded. This tape monitoring (or B-test) is obtained by depressing the SOURCE/TAPE button.

Alternate source and tape monitoring checks during recording should reveal no difference between source and tape.

Mono

For mono monitoring, use the SOURCE/TAPE button (L or R) corresponding to the depressed REC SELECT button (L or R).

Stereo

For stereo monitoring depress or release both SOURCE/TAPE buttons simultaneously.

Note: The S ON S switch must be in the NORM position for all monitoring operations.

Playback

Mono

Connect speakers, headphones or external amplifiers as explained on pages 5 and 6. Use the counter to find the program to be played back. Set the START/STOP lever to STOP. Depress the SOURCE/TAPE button for the channel to be used to position TAPE and set the tape transport lever to position ►. Start playback by moving START/STOP lever to START.

The reproduced program will be fed to both speakers. The output to the speakers can be adjusted with the OUTPUT LEVEL controls on the top panel. Return the tape transport lever to the centre position when playback has ended.

The START/STOP lever can be used for short pauses.

Stereo

The procedure for stereo playback is the same as for mono playback, except that both SOURCE/TAPE buttons must be depressed to position TAPE. The reproduced stereo program will be fed to the outputs for the respective channels.

Tone controls

The independent bass control affects both stereo channels on playback only, with a 15 dB range at 100 Hz. The independent treble control is similarly effective over a 15 dB range at 10 000 Hz.

Note: See also **Tape tracks** on page 12.

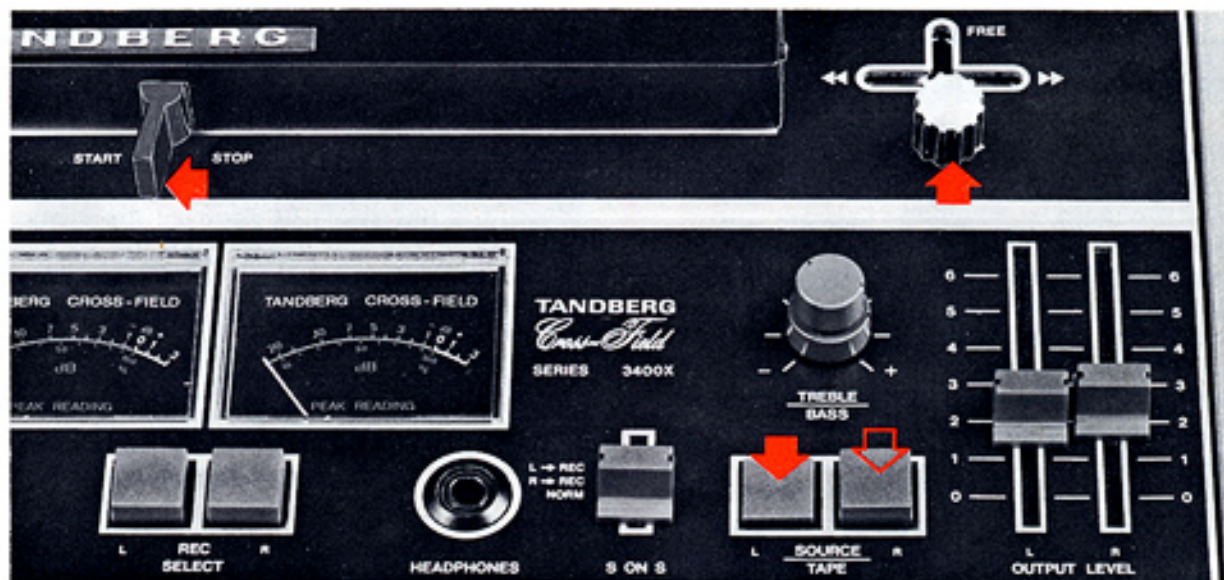

The recorder used as a microphone amplifier

Connect microphone(s) as described on page 5, and set the corresponding INPUT LEVEL to position 2 to 3.

MODE	REC SELECT	SOURCE/TAPE
Mono	Depress button for desired channel	Release both buttons
Stereo	Depress both buttons	Release both buttons

Adjust the volume with OUTPUT LEVEL but be careful not to cause howling.

Combined playback/amplifier function

A program can be played back in mono while the recorder is simultaneously used as a microphone amplifier.

Set the S ON S switch to position L → REC when playing back from channel L and to R → REC when playing back from channel R. The microphone must be connected to the MIC L socket.

Set the START/STOP lever to STOP. Both SOURCE/TAPE buttons must be in the released (SOURCE) position. Depress either of the REC SELECT buttons. Set both OUTPUT LEVEL controls to approx. mid-position. Speak into the microphone and adjust INPUT



L to obtain a reasonable level out from the speakers without acoustic howl. Move the tape transport lever to position ►. Start the playback by operating the START/STOP lever. Adjust the level of the music in the speakers by means of INPUT R.

Both the program played back and the microphone program will now be reproduced in both speakers.

If both REC SELECT buttons are released, the playback program will be heard in the R speaker and the microphone program will be heard in the L speaker.

When it is necessary to interrupt the music program to use the microphone for an announcement, turn up INPUT LEVEL L to the predetermined position and turn down the music with INPUT LEVEL R until the desired balance between speech and music is obtained. After completing the announcement, set INPUT LEVEL L to zero and reset the music level.

Note: The REC button must **not** be depressed.

Program editing

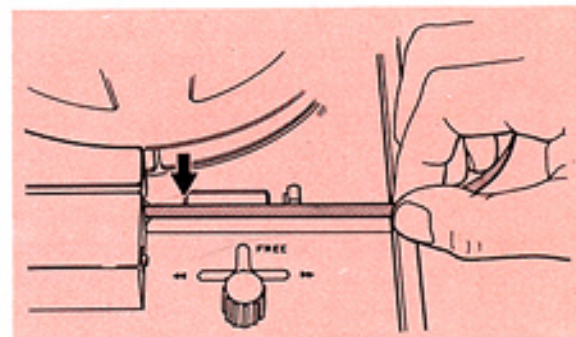

Programs are not always recorded in the same sequence as they are required for playback. It may therefore be necessary to edit tapes, i.e. cut and splice to present the program in the desired sequence. When a cutting point has been located during playback, stop the tape instantaneously by means of the START/STOP lever.

Take hold of the tape at the right hand tape-guide-post, and pull it out to the inner edge of the cabinet. The tape transport lever must remain in position ►. The point at which the tape should be cut (see Tape Splicing, page 12 is now at the left end of the counter window.

Note: Cutting and splicing for editing purposes must not be performed if there is a second program of value on another track.

Sound-on-Sound

The sound-on-sound recording technique allows a program played back from one track to be mixed with another program and re-recorded on another track on the same tape. With this technique you can add your own voice to a recording of an orchestra, you can sing in many voices by adding one voice after the other, or you can play many instruments, forming a band with yourself as the only musician.

Assuming that the first (original) program has been recorded in the normal way on the top track (left channel) Sound-on-Sound recording can be carried out as follows (voices are used in this example):

1. Connect a microphone to MIC L and headphones to the socket HEADPHONES.
2. Ensure both SOURCE/TAPE buttons are released (out) and both OUTPUT LEVEL control are at zero.
3. Set S ON S switch to L → REC and depress the REC SELECT R button.
4. Depress REC button, move tape transport lever to ► and move START/STOP lever to START.
5. Adjust INPUT LEVEL R so that the right-hand meter indicates slightly less than 0 dB.
6. Sing into the microphone and listen through the headphones. Adjust INPUT LEVEL L to obtain the desired balance between the first and second voices. If record level meter reads more than 0 dB, re-adjust the INPUT LEVEL R.

Try out steps 3 to 6 first as a test to establish the correct input levels. Then rewind to

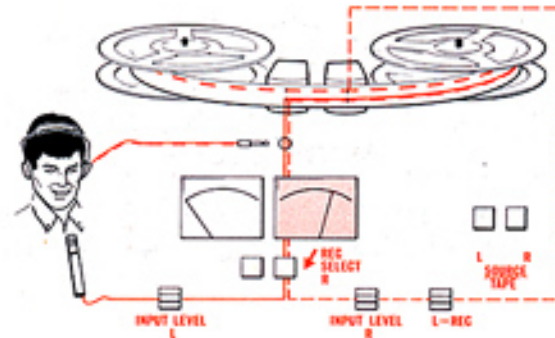

the beginning of the program. Press REC button and move tape transport lever to ►. Move START/STOP lever to START. Listen through the headphones to follow the tune. If adding a third voice, record program on top track (left channel). The procedure remains the same except for step 3 which will change to:

3. Set S ON S switch to position R → REC and depress the REC SELECT L button.

The adjacent figure shows the sound-on-sound procedure assuming that playback of the first (original) program is from the top track (channel L) and the new recording goes on to the other track (channel R).

Note: Whichever channel is used for recording, the new program must always be fed to one of the left (L) inputs. Any program source connected to a right (R) input must be disconnected to avoid disturbance.

Flying start – playback to recording

For editing purposes or other reasons you may wish to start a new recording immediately following something already recorded on the tape. This can most easily be done by going direct from playback to recording using the flying start feature.

WARNING

Flying start recording implies a risk of accidental unwanted erasure of the program and should be carried out with caution. Particularly observe step 2 in the following procedure:

1. For mono recording, press the appropriate SOURCE/TAPE button (L or R). For stereo recording press both SOURCE/TAPE buttons (L and R).
2. Ensure that both REC SELECT buttons are released (out).
3. Depress the REC button while moving the tape transport lever to ►.
4. Start the tape by moving the START/STOP lever to START and listen to the program played back.
5. When you want to make the new recording, depress the REC SELECT button for the channel in question (both REC SELECT buttons if the program is in stereo).
6. To resume playback of the prerecorded program on the tape, release the REC SELECT button(s).

Mixing

Two kinds of mixing are possible during recording, the **uncontrolled** type and the **controlled** type.

Uncontrolled mixing results from connecting programs to more than one of the left (L) inputs or more than one of the right (R) inputs (MIC, RADIO or PHONO) and the mixing ratios are not affected by the 3400X input level controls (although they may be affected by controls on the individual program sources).

Uncontrolled mixing is obtained in stereo (both REC SELECT buttons depressed).

Controlled mixing results from connecting one program to one of the left inputs (MIC, RADIO or PHONO) and a second program to one of the right inputs (MIC, RADIO, or PHONO), and the mixing ratio of the two programs is affected by the respective input level controls on the 3400X. Controlled mixing is for mono only (only one REC SELECT button depressed).

A combination of controlled and uncontrolled mixing may also be obtained but, again, only in mono (only one REC SELECT button depressed).

Mixing is also possible when the recorder is used in the amplifier mode.

For all mixing operations the S ON S switch must be at NORM.

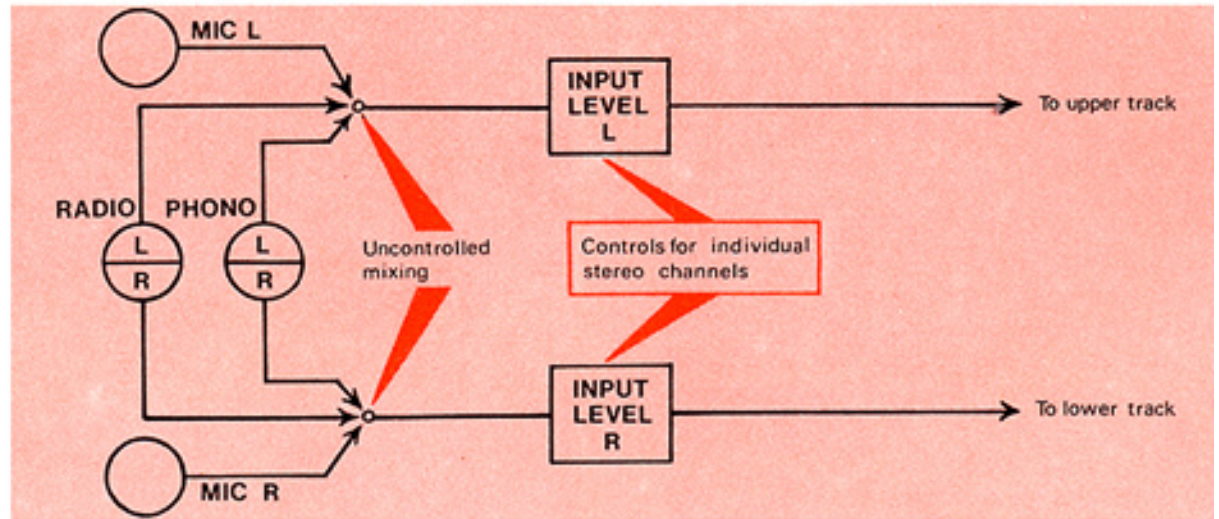

MIXING – stereo (both REC SELECT buttons depressed).

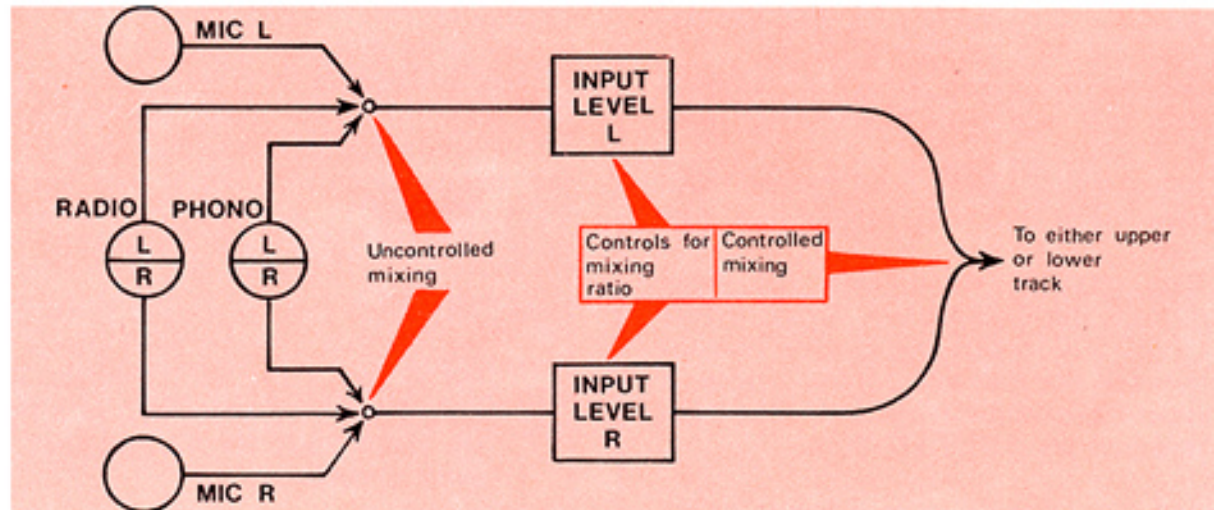

MIXING – mono (only one REC SELECT button depressed).

Echo

The physical separation of the recording and playback heads can be utilized to produce echo effects during mono recording. The echo time is longest at the lowest tape speed.

Assume the echo is to be recorded on channel L.

The following 10 steps should be first carried out as a test recording to establish the correct levels. When this procedure has been completed, rewind to the beginning of the tape and start the actual echo recording.

1. Connect the program to be recorded with echo into one of the L inputs.
2. Connect stereo headphones to socket HEADPHONES.
3. Set S ON S switch to L → REC and OUTPUT LEVEL controls to zero.
4. Set START/STOP lever to STOP.
5. Depress REC SELECT L button.
6. Depress REC button while moving tape transport lever to ►.
7. Adjust the record level of the input program with INPUT LEVEL L to obtain an indication slightly below 0 dB on the left-hand meter.
8. Start the recording by moving the START/STOP lever to START.
9. Set the echo level as desired with INPUT LEVEL R. Watch the record level meter of the channel used for recording to ensure that the echo does not cause the record level to exceed 0 dB. If necessary, re-adjust INPUT LEVEL L and

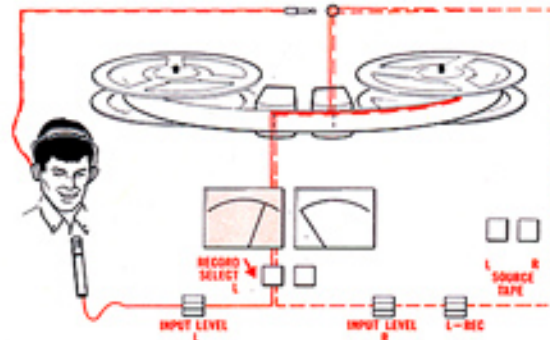

R to obtain correct level and desired echo.

Note: If the echo is turned up too much, the recorder may oscillate and spoil the recording.

An echo recording on channel R is carried out in exactly the same manner except that steps 3 and 5 should read as follows:

3. Set ON S switch to R → REC and OUTPUT LEVEL controls to zero.
5. Depress REC SELECT R button.

Note: Do not forget to return the S ON S switch to OFF/NORM when the echo recording has been completed.

Language learning

For language learning use the sound-on-sound technique. The following procedure assumes that the master program is prerecorded on the left (L) channel (the top track) with suitable gaps for student response. This program is played back, mixed with the student response and re-recorded on the right (R) channel (the other track).

Recording

Connect headphones to socket HEADPHONES. Connect microphone to MIC L. Set START/STOP lever to STOP position and S ON S switch to position L → REC.

Depress REC SELECT R button. Depress REC button while moving tape transport lever to position ►.

Leave both SOURCE/TAPE buttons in position SOURCE.

The INPUT LEVEL R knob, controlling the level of the transferred master program, should be set to position 3 approximately. When speaking into the microphone, adjust INPUT LEVEL L for 0 dB on right-hand level meter. Operate the START/STOP lever. Listen to the master program and repeat the exercises during the pauses.

Playback

Depress channel R SOURCE/TAPE button (position TAPE) and listen to the mixed program (master and student) in headphones.

Tape tracks

4-track models

If your tape recorder has 4-tracks, recording and playback can take place from either end of the tape in mono or stereo according to the instructions on pages 6 and 7.

The location of the 4-tracks across the width of the tape is such that when starting from one end of the tape, track 1 will be recorded if REC SELECT L is depressed, and track 3 will be recorded if REC SELECT R is depressed. When starting from the opposite end of the tape, recording will take place on track 4 when REC SELECT L is depressed, and on track 2 when REC SELECT R is depressed.

In mono playback of a 4-track tape, track 1 is selected by depressing SOURCE/TAPE L, and track 3 by depressing the SOURCE/TAPE R button when playing from one end of the tape. When playing from the opposite end of the tape, track 4 is selected by depressing SOURCE/TAPE L, and track 2 by depressing SOURCE/TAPE R. The diagram shows a 4-track tape system.

2-track models

If your recorder has 2-tracks, recording and playback can take place from either end of a tape in stereo or mono according to the instructions on pages 6 and 7. But notice that a stereo recording made from one end of a tape occupies the full width of the tape

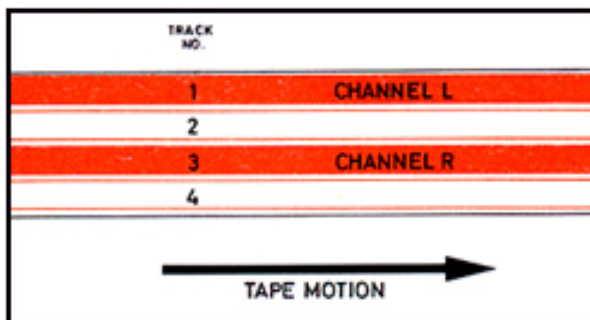

Starting from one end of the tape

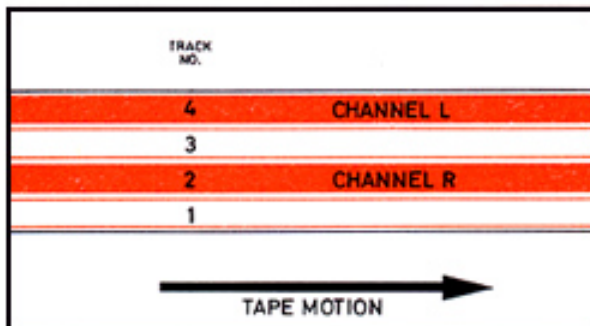

Starting from the other end of the tape

so that recordings cannot be made from the other end. Notice also that when a mono recording has been made from one end of a tape and the tape has been turned over and returned to the left-hand turntable ready for recording from the other end of the tape, the position of the REC SELECT buttons should not be changed.

Note: To help identify the ends of a reel of tape it is recommended that coloured leader tape be used. Red and green are colours commonly in use. Leader tape may be spliced to recording tape as explained in the next paragraph.

Tape splicing

For editing purposes, or if the tape has snapped, or if leader tape is needed, the ends must be spliced.

Lay the ends of the tape over each other with the same side of the tape facing upwards. Cut the tape with scissors or knife (non-magnetic) at an angle of about 45 degrees.



Lay the tape ends against each other, shiny side up. Lay the splicing tape across the join, parallel to the cut, and press firmly, squeezing out any air bubbles.



Cut the splicing tape along both edges. The cut should curve slightly into the edge of the recording tape to prevent adhesive on the splicing tape from being deposited on the magnetic heads.

Note: Adhesive tape which is not expressly intended for splicing of recording tapes must under no circumstances be used.



Plugs

Wiring diagrams for plugs to be connected to input and output sockets on series 3400X.

Note: The plugs are seen from the wiring side.



MIC – telephone jack



Screen.
Signal from microphone.
Signal from microphone.

Ring and sleeve are interconnected on the socket.

MIC – DIN plug

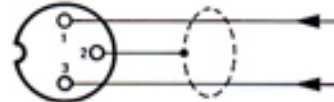

Signal from microphone.
Screen.
Signal from microphone.

Pins 1 and 2 are interconnected on the socket.

PHONO – DIN plug

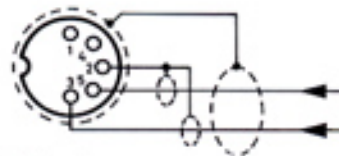

Pin 2 earth
Pins 1 and 5 are interconnected to the socket.
Pin 3 left channel

RADIO – DIN plug



1. Signal from receiver/amplifier, left channel.
4. Signal from receiver/amplifier, right channel.
2. Common lead (screen).
5. Signal to receiver/amplifier, right channel.
3. Signal to receiver/amplifier, left channel.

HEADPHONES – telephone jack



Channel L
Channel R
Screen.

LOUDSPEAKER – DIN plug

Flat pin earth
or negative.

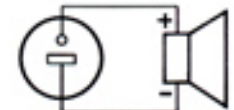

MODE OF OPERATION	POSITION OF BUTTONS AND SWITCHES				PROGRAM AT OUTPUTS	REMARKS
	REC SELECT L R	REC	SOURCE/TAPE L R	S ON S SWITCH		
Mono recording on channel L with program monitoring (source/tape tests)				NORM	Source test: Mono source to both channels Tape test: Mono tape to both channels	L and R inputs will be mixed.
Mono recording on channel R with program monitoring (source/tape tests)				NORM	Source test: Mono source to both channels Tape test: Mono tape to both channels	L and R inputs will be mixed.
Stereo recording with program monitoring (source/tape tests)				NORM	Source test: Stereo source to respective channels Tape test: Stereo tape to respective channels	Playback buttons must be operated simultaneously for source/tape tests.
Mono playback from channel L.				NORM	Mono L program to both channels	
Mono playback from channel R.				NORM	Mono R program to both channels	
Stereo playback.				NORM	Stereo program to respective channels	
Mono amplifier – channel L.				NORM	Mono program to both channels	
Mono amplifier – channel R.				NORM	Mono program to both channels	
Stereo amplifier.				NORM	Stereo program to respective channels	
Playback from channel L while using channel R as microphone amplifier.				L → REC	Playback program and mic. program to both channels.	Microphone must be connected to MIC L, and the level adjusted with INPUT LEVEL L. INPUT LEVEL R controls playback program.
Playback from channel R while using channel L as microphone amplifier.				R → REC	Playback program and mic. program to both channels.	Microphone must be connected to MIC L, and the level adjusted with INPUT LEVEL L. INPUT LEVEL R controls playback program.
Sound-on-sound recording on channel L.				R → REC	Sound-on-sound program to both channels	Microphone must be connected to MIC L, and the level controlled with INPUT LEVEL L. Playback program is controlled with INPUT LEVEL R.
Sound-on-sound recording on channel R.				L → REC	Sound-on-sound program to both channels	Microphone must be connected to MIC L, and the level controlled with INPUT LEVEL L. Playback program is controlled with INPUT LEVEL R.
Echo recording on channel L.				L → REC	Echo program to both channels	Connect microphone to MIC L and control the level with INPUT LEVEL L while echo level is adjusted with INPUT LEVEL R. Note: Do not set INPUT LEVEL R so high that echo becomes distorted.
Echo recording on channel R.				R → REC	Echo program to both channels	Connect microphone to MIC L and control the level with INPUT LEVEL L while echo level is adjusted with INPUT LEVEL R. Note: Do not set INPUT LEVEL R so high that echo becomes distorted.

Maintenance

When the tape recorder is used, dust and particles from the tape will deposit on heads and guide posts. The deposit will cause a reduced signal-to-noise ratio and impaired treble reproduction, and may also cause drop-outs. Inspection and cleaning of the tape path should be performed regularly, before the symptoms become noticeable. Tape of the best quality is highly recommended because, in addition to giving better sound reproduction it also leaves less deposit and causes less wear on the heads. Cleaning should be performed at intervals of 1 to 2 months dependent on use, tape quality, operating temperature and the amount of dust in the environment.

Cleaning and lubrication of motor and tape drive mechanism should only be performed in an authorized service workshop at intervals of two to three years (less often if the machine is not in regular use).

Inspection

Remove the front head cover by depressing the spring loaded buttons at both ends, and lifting the cover straight upwards. The tape transport lever should be in the centre position. The back cover can be lifted off when the button on its rear side is depressed. Inspect for contamination of the parts shown in the figure. Pay particular attention to the sharp corners of the tape guide posts where deposits tend to settle (tape edge). Replace the head covers.

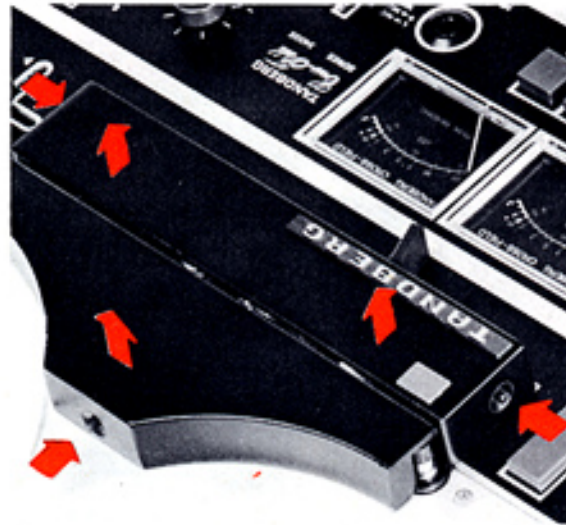

Cleaning

The cleaning can be done with cotton wool or a piece of flannel wrapped around a small stick and moistened with methylated spirit. A kit intended for this purpose, "Tandberg Professional Tape Head Cleaner", containing a number of plastic pins with cotton buds and bottle with nonflammable cleaning liquid is available. Solvents such as **acetone or trichlorethylene must not be used**, as these may damage the heads. Clean at the spots indicated in the figure. The pressure pad pressing the tape against the tape rest must not be moistened as this will upset the friction conditions. The pressure pad must be cleaned only with a dry brush.

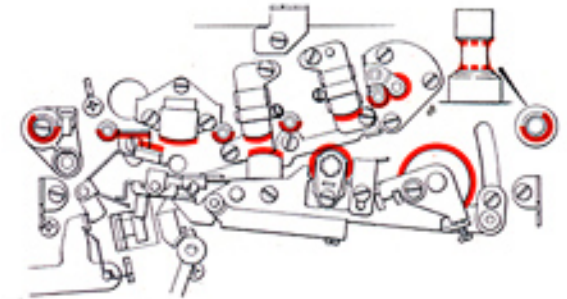

Degaussing

After approximately every 100 hours of use the heads and tape path should have the stray permanent magnetization removed (degaussing). Follow the degausser makers instructions or consult your dealer. Take great care not to let the degausser **touch** the heads or metal parts in the tape path.

Note: Care should be taken not to disturb the position of heads or guide posts.

Useful Data

Dimensions:

Width: 15³/₄" (40 cm). Depth: 16¹/₈" (41 cm). Height: 7" (18 cm).

Weight:

26 lb (11.8 kg)

Power requirements:

240/230/115 V, 50/60 Hz.

Power consumption:

130 watts.

Tone range:

(according to DIN 45511)

7¹/₂ ips: 30 to 25 000 Hz

3³/₄ ips: 30 to 18 000 Hz

1⁷/₈ ips: 30 to 10 000 Hz

Inputs

	Sensitivity	Max. voltage	Impedance	Type of plug
MIC	140 μ V	25 mV	For 200-600 ohm mic	DIN
RADIO	8 mV	1.2 V	50 kohms	DIN
PHONO	1 mV	100 mV	33 kohms	DIN

Outputs

	Voltage/ power	Load impedance	Type of plug
RADIO	1 V	min 5 kohms	DIN
HEADPHONES	1 V	min 100 ohms	Phone jack
SPEAKERS	15 W (4 ohms)	4-8 ohms	DIN

For a full technical specification, see the Tandberg Main Catalogue.



TANDBERGS RADIOFABRIKK A/S

Kjelsåsveien 161 – Oslo – Norway